

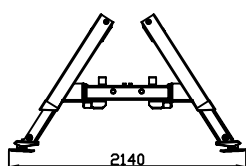

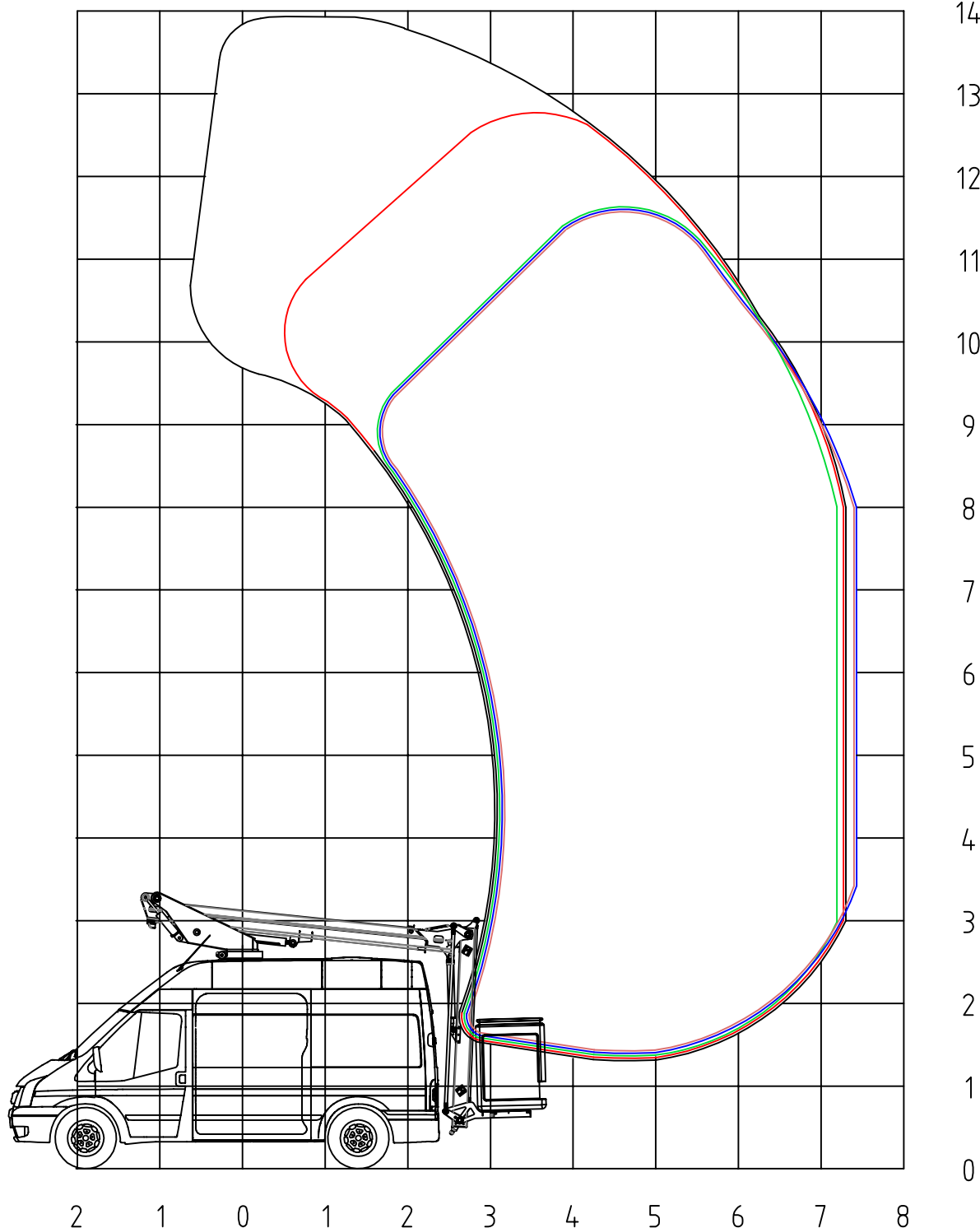



1 METER



-  Støttebensopstilling 1 (LED 1)
-  Støttebensopstilling 3 (LED 3)
-  Støttebensopstilling 4 (LED 4)
-  Støttebensopstilling 6 (LED 6)
-  Støttebensopstilling 7 (LED 7)



PLATFORM: DANILIFT

TYPE: P140V

EQUIPMENT:

DWG BY:
Henrik

DATE:
13.09.2011

REV:
23.11.2011

VEHICLE: FORD

TYPE: TRANSIT 350

DRAWING:
I:\LIFTDATA\LEV & IGANGVÆRENDE LIFTE\DANILIFT
P-SERIE\P140V\32140100 PALFINGER NORGE02 - TEKNISK
SPECIFIKATIONER\ARBEJDSDIAGRAM SIDE P140V 32140100

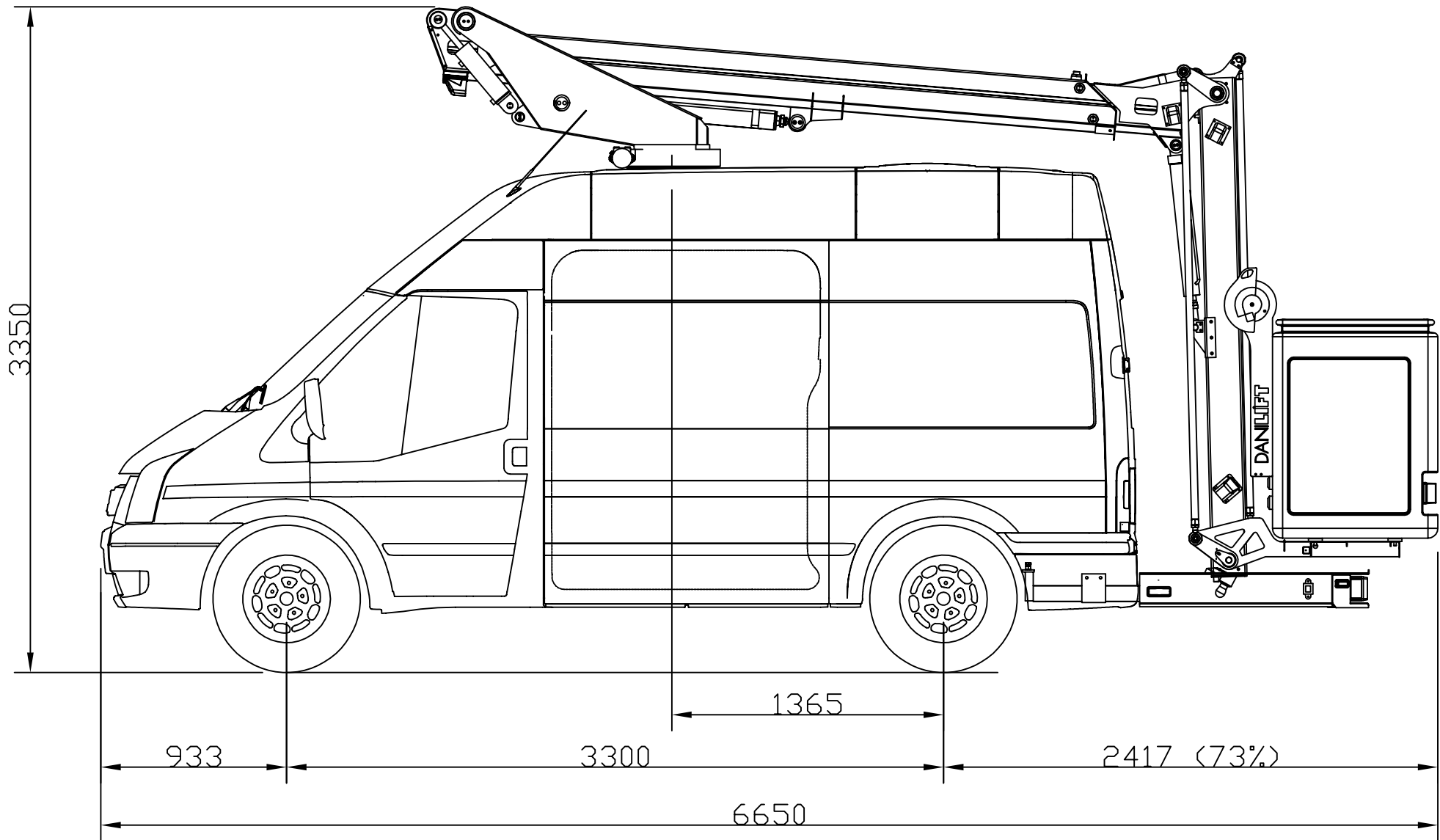

PLATFORM: DANILIFT

TYPE: P140V

EQUIPMENT:

DWG BY:
Henrik

DATE:
13.09.2011

REV:
05.11.2012

VEHICLE: FORD

TYPE: TRANSIT 350

DRAWING:
LIFTDATALEV. & IGANGVÆRENDE LIFTE\ DANILIFT P-SERIE\ P140V\ 32140100
DANILIFT A-S02 - TEKNISK SPECIFIKATIONER \
DRAWING P140V 32140100